

Product data sheet

Specifications



single function relay, Harmony
Timer Relays, 0.7A, 1s..100h, off
delay, solid state output, 24 to 240V
AC

RE17LCBM

Product availability: Stock - Normally stocked in distribution facility

Main

Range of Product	Harmony Timer Relays
Discrete output type	Solid state
Width	0.7 in (17.5 mm)
Product or Component Type	Modular timing relay
Component name	RE17L
Time delay range	10...100 h 6...60 s 6...60 min 1...10 h 1...10 s 1...10 min 0.1...1 s
nominal output current	0.7 A

Complementary

Height	3.5 in (90 mm)
Depth	2.8 in (72 mm)
Control type	Selector switch front panel
[Us] rated supply voltage	24...240 V AC 50/60 Hz
Voltage range	0.85...1.1 Us
Supply frequency	50...60 Hz +/- 5 %
release of input voltage	7 V
control signal pulse width	0.05 s typical
Insulation resistance	100 MOhm 500 V DC IEC 60664-1
[Uimp] rated impulse withstand voltage	5 kV 1.2/50 µs
power on delay	100 ms
Connections - terminals	Screw terminals, 1 x 0.5...1 x 3.3 mm ² AWG 20...AWG 12) solid without cable end Screw terminals, 2 x 0.5...2 x 2.5 mm ² AWG 20...AWG 14) solid without cable end Screw terminals, 1 x 0.2...1 x 2.5 mm ² AWG 24...AWG 14) flexible with cable end Screw terminals, 2 x 0.2...2 x 1.5 mm ² AWG 24...AWG 16) flexible with cable end
Tightening torque	5.3...8.9 lbf.in (0.6...1 N.m) IEC 60947-1
Dielectric strength	2.5 kV 1 mA/1 minute 50 Hz IEC 61812-1
Housing material	Polycarbonate
Repeat accuracy	+/- 0.5 % IEC 61812-1
Temperature Drift	+/- 0.05 %/°C

Price is "List Price" and may be subject to a trade discount – check with your local distributor or retailer for actual price.

Voltage drift	+/- 0.2 %/V
Setting accuracy of time delay	+/- 10 % of full scale 25 °C IEC 61812-1
Time delay type	Off-delay - C- Off-delay relay w/ control signal
Reset time	350 ms on de-energisation typical
On-load factor	100 %
Power consumption in VA	0...3 VA 240 V AC
Breaking capacity	0.5 A AC UL 0.7 A AC 68 °F (20 °C)
operating frequency	10 Hz
Maximum output current	20 A
minimum switching current	10 mA
Maximum leakage current	5 mA
Maximum switching voltage	250 V AC
Maximum voltage drop	<4 V 3-wire <8 V 2-wire
Electrical durability	100000000 cycles
Marking	CE
Creepage distance	4 kV/3 IEC 60664-1
Safety reliability data	MTTFd = 353.8 years B10d = 320000
Mounting position	Any position in relation to normal vertical mounting plane
Mounting support	35 mm DIN rail conforming to IEC 60715
Function available	C- Off-delay relay w/ control signal-1 solid state output
Control Type	Without test button
Net Weight	0.150 lb(US) (0.068 kg)
Time delay type	C
Functionality	Off-delay timing
Number of functions	1
Compatibility code	RE17

Environment

Immunity to microbreaks	20 ms
Derating factor	5 mA/°C
Standards	2004/108/EC IEC 61000-6-3 2006/95/EC IEC 61000-6-2 IEC 61812-1 IEC 61000-6-4 IEC 61000-6-1
Product Certifications	CSA GL cULus
Ambient Air Temperature for Storage	-22...140 °F (-30...60 °C)
Ambient Air Temperature for Operation	-4...140 °F (-20...60 °C)

IP degree of protection	IP20 IEC 60529 terminal block) IP40 IEC 60529 housing) IP50 IEC 60529 front panel)
Vibration resistance	20 m/s ² (f= 10...150 Hz) conforming to IEC 60068-2-6
Shock resistance	15 gn 11 ms IEC 60068-2-27
Relative Humidity	93 % without condensation IEC 60068-2-30
Electromagnetic compatibility	Electrostatic discharge immunity test 6 kV in contact) level 3 IEC 61000-4-2 Electrostatic discharge immunity test 8 kV in air) level 3 IEC 61000-4-2 Susceptibility to electromagnetic fields 10 V/m 80 MHz to 1 GHz) level 3 IEC 61000-4-3 Electrical fast transient/burst immunity test 1 kV capacitive connecting clip) level 3 IEC 61000-4-4 Electrical fast transient/burst immunity test 2 kV direct) level 3 IEC 61000-4-4 1.2/50 µs shock waves immunity test 1 kV differential mode) level 3 IEC 61000-4-5 1.2/50 µs shock waves immunity test 2 kV common mode) level 3 IEC 61000-4-5 Conducted RF disturbances 10 V 0.15...80 MHz) level 3 IEC 61000-4-6 Voltage dips and interruptions immunity test 0 % 1 cycle) IEC 61000-4-11 Voltage dips and interruptions immunity test 70 % 25/30 cycles) IEC 61000-4-11 Conducted and radiated emissions class B EN 55022

Ordering and shipping details

Category	US10CP222370
Discount Schedule	0CP2
GTIN	3606480552632
Returnability	Yes
Country of origin	ID

Packing Units

Unit Type of Package 1	PCE
Nbr. of units in pkg.	1
Package 1 Height	1.06 in (2.7 cm)
Package 1 Width	3.07 in (7.8 cm)
Package 1 Length	3.7 in (9.5 cm)
Package weight(Lbs)	2.5 oz (71.0 g)
Unit Type of Package 2	S02
Number of Units in Package 2	40
Package 2 Height	5.9 in (15.0 cm)
Package 2 Width	11.8 in (30.0 cm)
Package 2 Length	15.7 in (40.0 cm)
Package 2 Weight	7.381 lb(US) (3.348 kg)

Contractual warranty

Warranty (in months)	18
-----------------------------	----



Environmental Data

Schneider Electric aims to achieve Net Zero status by 2050 through supply chain partnerships, lower impact materials, and circularity via our ongoing “Use Better, Use Longer, Use Again” campaign to extend product lifetimes and recyclability.

[Environmental Data explained >](#)

[How we assess product sustainability >](#)



Environmental footprint

Total lifecycle Carbon footprint	70 kg CO2 eq.
Carbon footprint of the manufacturing phase [A1 to A3]	2 kg CO2 eq.
Carbon footprint of the distribution phase [A4]	0.1 kg CO2 eq.
Carbon footprint of the installation phase [A5]	0 kg CO2 eq.
Carbon footprint of the use phase [B2, B3, B4, B6]	68 kg CO2 eq.
Carbon footprint of the end-of-life phase [C1 to C4]	0.2 kg CO2 eq.
Environmental Disclosure	Product Environmental Profile

Use Better



Materials and Substances

Packaging made with recycled cardboard	Yes
Packaging without single use plastic	Yes
SCIP Number	7bdc2711-0ad2-427c-8ece-532c5e9f09d7
EU RoHS Directive	Compliant By Exemption
REACH Regulation	Reference contains Substances of Very High Concern above the threshold
California proposition 65	WARNING: This product can expose you to chemicals including: Lead and lead compounds, which is known to the State of California to cause cancer and birth defects or other reproductive harm. For more information go to www.P65Warnings.ca.gov

Use Longer



Lifetime extension

Repair	No
--------	----

Use Again



Repack and remanufacture

Recyclability potential, in %	13
Circularity Profile	End of Life Information
Take-back	No

Dimensions Drawings

Width 17.5 mm

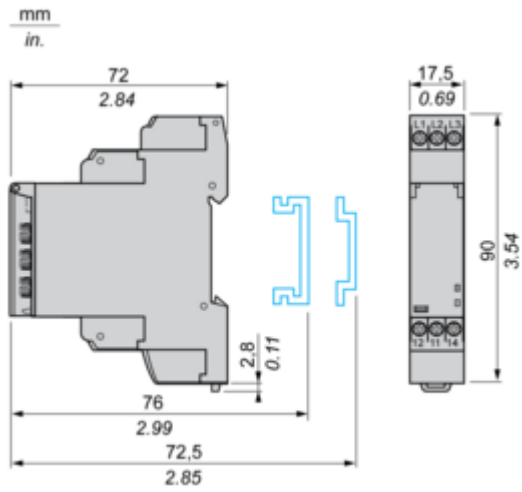

Connections and Schema

Internal Wiring Diagram

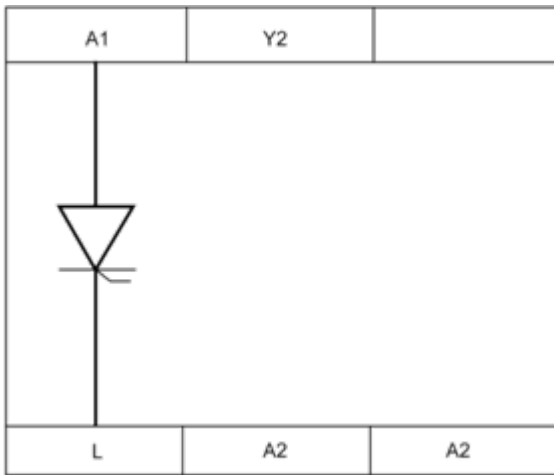

Wiring Diagram

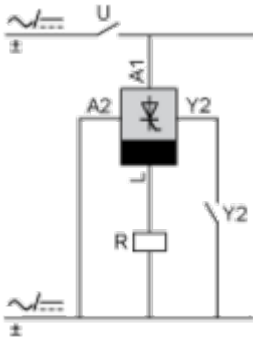

Technical Description

Function C : Off-Delay Relay with Control Signal

Description

After power-up and closing of the control contact C, the output R closes. When control contact C re-opens, timing T starts. At the end of the timing period, the output(s) R revert(s) to its/their initial state. The second output can be either timed or instantaneous.

Function: 1 Output

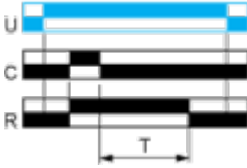



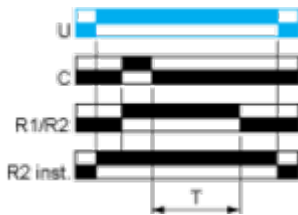

Function: 2 Outputs



2 timed outputs (R1/R2) or 1 timed output (R1) and 1 instantaneous output (R2 inst.)

Legend

-  Relay de-energised
-  Relay energised
-  Output open
-  Output closed

C	Control contact
G	Gate
R	Relay or solid state output
R1/R2	2 timed outputs
R2 inst.	The second output is instantaneous if the right position is selected
T	Timing period
Ta -	Adjustable On-delay
Tr -	Adjustable Off-delay
U	Supply

Technical Illustration

Dimensions

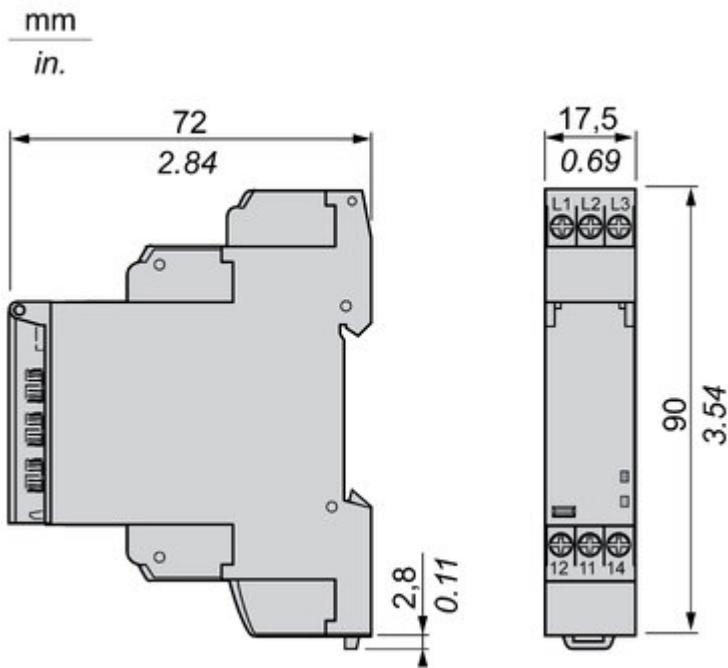

Offer Marketing Illustration

Product benefits / Features

Technical Benefits

Harmony Timer Relay

Flexible choice of screw or spring connection terminals for wiring.

One product reference covering 28 timing functions, 2 outputs, and a wide range of supply voltage 24...240 V AC/DC.

Dust and unintended human intervention avoided thanks to the IP50 lead-sealable settings protection cover.



A Dial-Pointer LED indicator that enhances ease of operation in difficult environments such as dusty or low-light conditions

Different mounting style to meet your preference:
DIN rail mount with product width; 17.5 mm/0.69 in. 22.5 mm/0.88 in.
Plug in mounting with socket



Offer Marketing Illustration

Product benefits / Features



Features

Harmony Timer Relay

- 

"Diagnostic button" to check downstream circuit immediately, shorten the commission and troubleshooting time
- 

Compatible with a wide range of applications including machines, buildings, water segments, and HVAC.
- 

Wide range of time delay for adjustment: from 0.01 s to 999 hrs.
- 

Compliant with IEC 60255-1 standard, and a wide array of product certifications such as UL, CE, CSA, EAC.
- 

Unprecedented accuracy, predictive maintenance, and superior security.

Image of product / Alternate images

Alternative





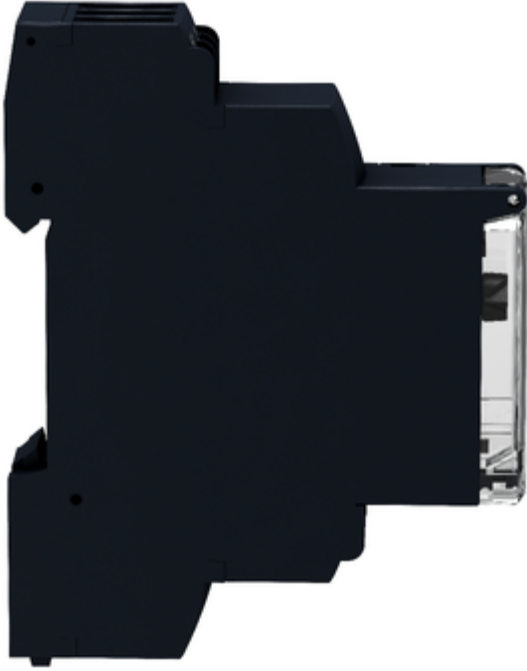

Image of product in real life situation

